

Genuine
HAND FORGED
Automobile Mechanics'
TOOLS

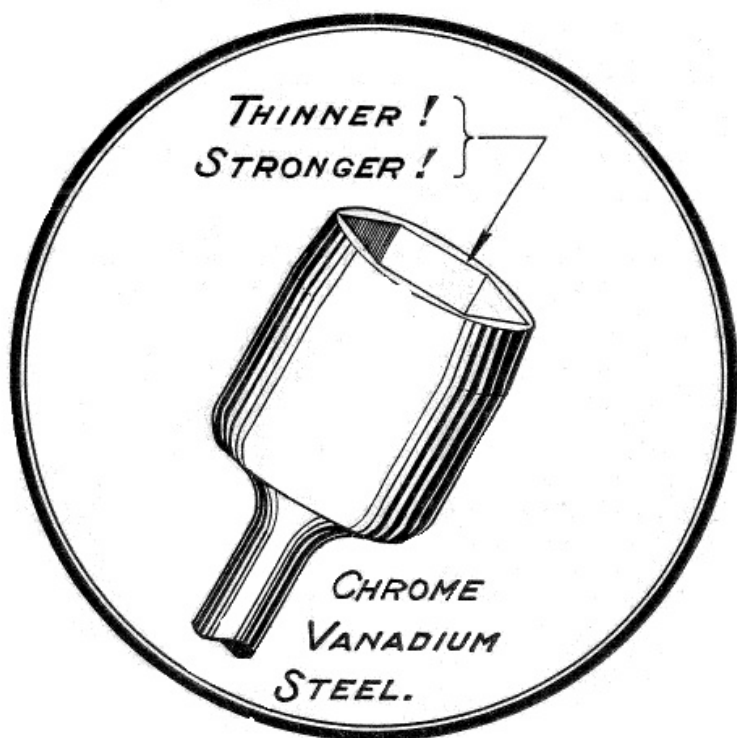

PETERSON & CARLBORG, INC.

Manufacturers

MILWAUKIE, OREGON

(Suburb of Portland, Oregon)

"We Couldn't Keep Our Tools, So We Quit the Garage Business!"



John N. Peterson



Charles F. Carlborg

The firm of Peterson & Carlborg used to be in the garage business. And while in this business we made this important discovery: that the cheapest tools the automobile mechanic can buy are those that will last the longest and enable him to do the most work in the shortest space of time, **regardless of first cost.**

We were both tool makers and learned our tool-making trade from our fathers in Sweden, who were also tool makers. Naturally, when we couldn't buy the kind of tools we wanted, we made them

ourselves out of the toughest steel obtainable, by a process of hand forging and tempering which we learned in the old country.

We had no idea then of going into the tool-making business. But so many mechanics and fellow garage men used to beg, borrow and buy them that we found there was a big demand for hand forged tools. Without exception, every automobile man who has used them tells us they are the best tools he has ever used.

Hand Forged from Chrome Vanadium Steel—Thinner Walls!

Scientific heat treatment and hand forging give these tools wear-resisting qualities and great strength, which has been proven to be unexcelled after two years on the market.

The fine grade of steel, together with the hand forging, permits the socket wrenches to be made with a thinner wall, which gives greater allowance for clearance.

All tools carry a guarantee against defective material or workmanship—which will be made good when tool claimed to be defective is returned to the factory—transportation charges prepaid.

Order From This Catalog

—through your jobber, or supply house, or send your order direct to the factory and it will be filled promptly.

P. & C. Tools Save You Time and Last Longer

By the year you will pay much less for tools if you buy Peterson & Carlborg, because our tools will outlast any others on the market. They also save you time. You can work faster and get more done when you use P. & C. tools.

Prices subject to change without notice.

PETERSON & CARLBORG, INC.

Genuine Hand Forged Tools

WRENCHES PUNCHES CHISELS SCREW DRIVERS LOOSE SOCKET SETS

Factory and Office: Milwaukie, Oregon

Suburb of Portland, Oregon

SOCKET SIZE TABLE

Socket Opening Inches	Fits S. A. E. Nuts Cap Screws	Fits U. S. S. Cap Screws	Fits U. S. S. Nuts and Bolt Heads (Unfinish.)
7/16	1/4	1/4	0
1/2	5/16	5/16	1/4
9/16	3/8	3/8	0
19/32	0	0	5/16
5/8	7/16	7/16	0
11/16	0	0	3/8
3/4	1/2	1/2	0
25/32	0	0	7/16
13/16	0	9/16	0
7/8	9/16	5/8	1/2
15/16	5/8	0	0
31/32	0	0	9/16
1	11/16	3/4	0
1 1/16	3/4	0	5/8
1 1/8	0	7/8	0
1 1/4	7/8	1	3/4

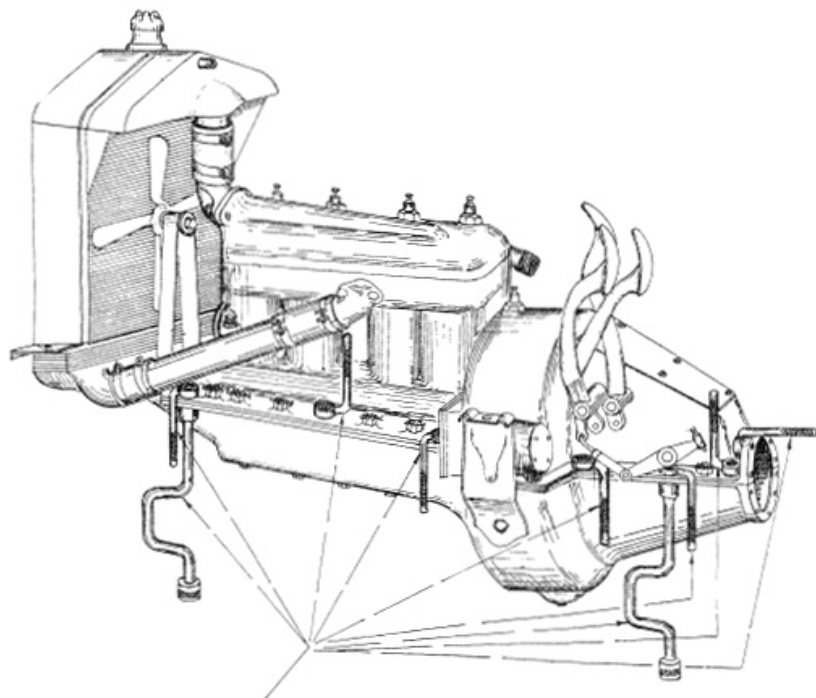

Showing how to use our "one man" wrench with a speed wrench on Ford and other motors. See opposite page for price.

Box Socket Wrench

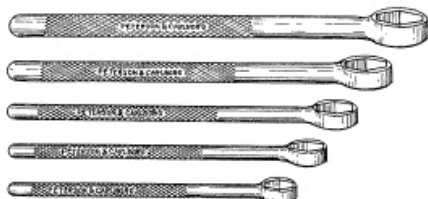

Hand Forged from one piece of Chrome Vanadium Steel

These wrenches have short sockets, very thin walls and can be used in very close places.

No.	Opening	Length	List Price
516	1/2	4 3/4	\$1.00
518	9/16	5	1.20
520	5/8	5 1/2	1.30
522	11/16	6	1.40
524	3/4	6 3/4	1.60
171	SET COMPLETE		6.00

Special Double Offset Socket Wrench

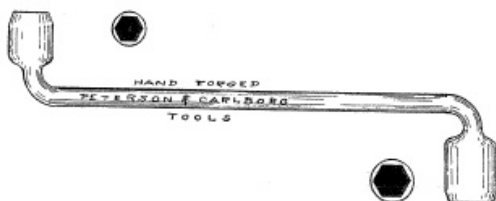

For Main Bearings and Connecting Rods

Hand Forged from one piece of Chrome Vanadium Steel

Note: These offset socket wrenches can be furnished with openings other than those specified. Send us your requirements.

No.	Openings	List Price	Car
445	9/16 sq. x 5/8 hex.	\$2.70	Ford
1824	9/16 x 3/4	2.00	Buick
1822	9/16 x 11/16	3.00	Studebaker
2428	3/4 x 7/8	3.50	Dodge
2420	3/4 x 5/8	3.50	Nash
1820	9/16 sq. x 5/8	2.70	Fordson Tractor

Special Double Offset Socket Wrench



Hand Forged from one piece of Chrome Vanadium Steel

For 1923-24 Chevrolet Connecting Rod and Main Bearing.

No.	Openings	List Price
5218	7/8 x 9/16	\$3.35

Hammer Head Wrench

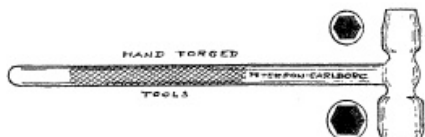

Sockets Hand Forged from one piece of Chrome Vanadium Steel

These hammer head wrenches can be supplied with openings other than those specified. Send us your requirements.

No.	Opening	List Price
402	7/16 x 1/2	\$2.95
404	1/2 x 9/16	2.95
406	9/16 x 5/8	2.95

L Type Double Socket Wrench



Hand Forged from one piece of Chrome Vanadium Steel

These L type wrenches can be furnished with openings other than those specified. Send us your requirements.

No.	Openings	Size	List Price
414	7/16 x 7/16	3x 8	\$2.50
416	1/2 x 1/2	3x 8	2.50
418	9/16 x 9/16	4x10	2.60
420	5/8 x 5/8	4x10	2.60
422	11/16 x 11/16	4x10	2.70

Ford Main Bearing Double Socket L Type Wrench

Same Design as above.

No.	Opening	List Price
444	9/16 sq. x 9/16 sq.	\$2.60

L Type Double Socket Wrench

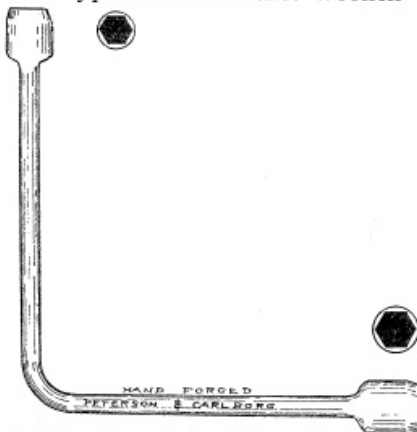

Hand Forged from one piece of Chrome Vanadium Steel

Note: These L type wrenches can be furnished with openings other than those specified. Send us your requirements.

No.	Openings	Size	List Price
275	9/16 x 11/16	7x7	\$2.65
258	7/16 x 1/2	7x7	2.65
259	11/16 x 5/8	7x7	2.65
260	3/4 x 7/8	7x7	3.35
261	5/8 x 9/16	7x7	2.65

"One Man" Offset Box Socket Wrench

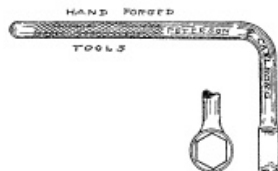

Hand Forged from one piece of Chrome Vanadium Steel
Very thin wall box socket wrench, hand forged from Chrome Vanadium steel. Can be used in very close places. See opposite page.

No.	Opening	List Price
-----	---------	------------

Short Bend Offset Socket Wrench



Hand Forged from one piece of Chrome Vanadium Steel

No.	Opening	List Price
1510	5/16	\$0.80
1514	7/16	0.90
1516	1/2	1.00
1518	9/16	1.10
1519	19/32	1.20
1520	5/8	1.20
1522	11/16	1.30
1524	3/4	1.50
1525	25/32	1.70
1526	13/16	1.80
1528	7/8	2.00
1530	15/16	2.20
1532	1	2.40
1534	1 1/16	2.50

Long Bend Offset Socket Wrench



Hand Forged from one piece of Chrome Vanadium Steel

No.	Opening	List Price
1610	5/16	\$1.00
1614	7/16	1.10
1616	1/2	1.20
1618	9/16	1.30
1619	19/32	1.30
1620	5/8	1.40
1622	11/16	1.50
1624	3/4	1.70
1625	25/32	1.90
1626	13/16	2.00
1628	7/8	2.20
1630	15/16	2.40
1632	1	2.60
1634	1 1/16	2.70

Ford Carburetor Wrench

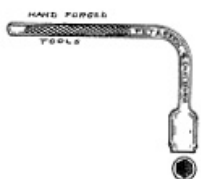

Hand Forged from one piece of Chrome Vanadium Steel
For removing Ford Carburetor without disconnecting manifold.

No.	Opening	List Price
918F	9/16	\$1.20

Ford Generator Third Brush Wrench



Hand Forged from one piece of Chrome Vanadium Steel
For adjusting third brush on Ford Generator

No.	Opening	List Price
-----	---------	------------

Ford Perch Nut Wrench



Hand Forged from one piece of Chrome Vanadium Steel

No.	Opening	List Price
1632	1	\$3.00

Ford Fourth Connecting Rod Wrench



Hand Forged from one piece of Chrome Vanadium Steel

This wrench is similar to 1520 except handle is swung 1 1/4" off square.

No.	Opening	List Price
1520F	5/8	\$1.40

Dodge Generator Wrench



Hand Forged from one piece of Chrome Vanadium Steel
For Inspection Plate

No.	Opening	List Price
611	1/2	\$1.20

Ford Main Bearing Offset Square Socket Wrench and Ford Flywheel Hexagon Socket Wrench



Hand Forged from one piece of Chrome Vanadium Steel

No.	Opening	List Price
617F	9/16 Sq.	\$1.80

Speed Wrench

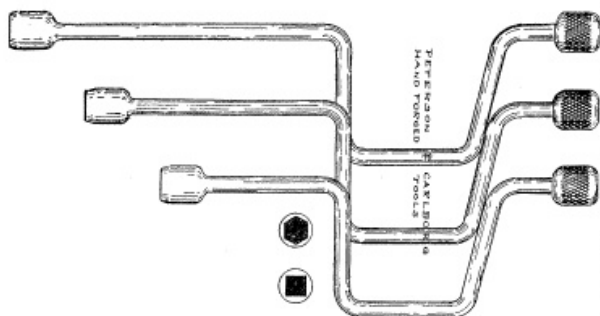

Sockets all hand forged from Chrome Vanadium steel. Easy grip handles.

SHORT SHANK (8" below bend)

No.	Opening	List Price
5514	7/16	\$1.60
5516	1/2	1.60
5518	9/16	1.60
5519	19/32	1.60
5520	5/8	1.60
5522	11/16	1.60
5524	3/4	1.80
5525	25/32	1.80
5526	13/16	1.90
5528	7/8	2.00
5530	15/16	2.00
5532	1	2.40
5534	1 1/16	2.40

LONG SHANK (10" below bend)

No.	Opening	List Price
6514	7/16	\$1.60
6516	1/2	1.60
6518	9/16	1.60
6519	19/32	1.60
6520	5/8	1.60
6522	11/16	1.60
6524	3/4	1.80
6525	25/32	1.80
6526	13/16	1.90
6528	7/8	2.00
6530	15/16	2.00
6532	1	2.40
6534	1 1/16	2.40

EXTRA LONG SHANK (16" below bend)

No.	Opening	List Price
7516	1/2	\$1.89
7518	9/16	1.80
7520	5/8	1.80

EXTRA LONG SHANKS (24" below bend)

No.	Opening	List Price
8516	1/2	\$2.00
8518	9/16	2.00
8520	5/8	2.00

Hand Forged Sockets for Speed Wrench Shanks



Hand Forged from Chrome Vanadium Steel

These sockets can be attached to any speed wrench shank by squaring shank and driving socket on.

No.	Opening	List Price
5614	7/16	\$0.80
5616	1/2	0.80
5618	9/16	0.80
5619	19/32	0.80
5620	5/8	0.80
5622	11/16	0.80
5624	3/4	1.00
5625	25/32	1.00
5626	13/16	1.00
5628	7/8	1.20
5630	15/16	1.20
5632	1	1.40
5634	1 1/16	1.40

Universal Speed Wrench

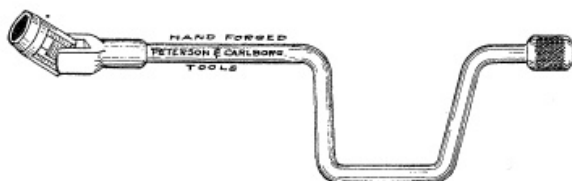

Sockets Hand Forged from one piece of Chrome Vanadium Steel

No.	Opening	List Price
9516	1/2	\$1.50
9518	9/16	4.50
9520	5/8	4.50
9522	11/16	4.50

Tee Wrench

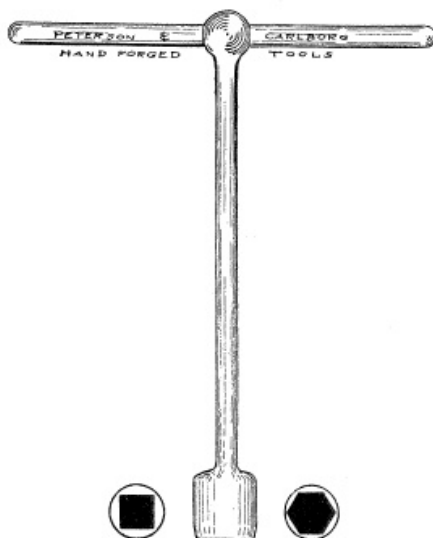

Socket and shank hand forged from one piece of Chrome Vanadium Steel.

6" SHORT SHANK

No.	Opening	List Price
2814	7/16	\$2.00
2816	1/2	2.10
2818	9/16	2.15
2820	5/8	2.25
2822	11/16	2.40
2824	3/4	2.40
2825	13/16	2.90
2828	7/8	2.90
2830	15/16	3.25
2832	1	3.60
2834	1 1/16	3.90

12" LONG SHANK

No.	Opening	List Price
4514	7/16	\$2.25
4516	1/2	2.40
4518	9/16	2.60
4519	19/32	2.60
4520	5/8	2.90
4522	11/16	3.00
4524	3/4	3.20
4525	25/32	3.20
4526	13/16	3.20
4528	7/8	5.40
4530	15/16	5.60
4532	1	3.90
4534	1 1/16	4.90

Universal Tee Socket Wrench

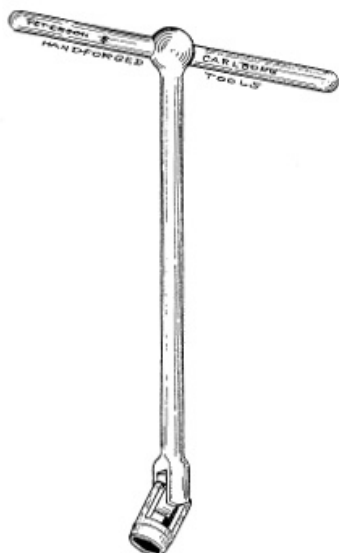

Socket and shank hand forged from one piece of Chrome Vanadium Steel.

12 inch

No.	Opening	List Price
3514	7/16	\$4.00
3516	1/2	4.00
3518	9/16	4.00
3520	5/8	4.20
3522	11/16	4.50
3524	3/4	4.50

Ford Fourth Connecting Rod Offset Shank Tee Wrench

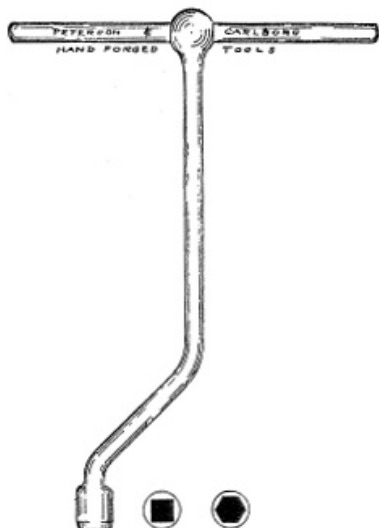

Hand Forged from one piece of Chrome Vanadium Steel

No.	Opening	List Price
---	---	---

Ford Front Main Bearing Straight Shank Tee Wrench

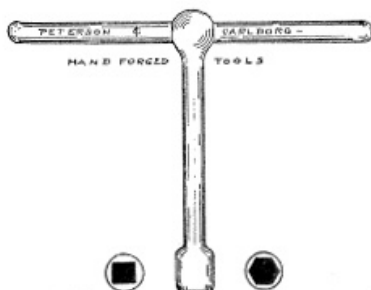

Socket and shank hand forged from one piece of Chrome Vanadium Steel.

No.	Opening	List Price
110F	9/16 Sq.	\$2.90

Ford Spindle Body Bushing Extractor



Also for Chevrolet and Overland

These bushing extractors are screwed into the bushing, allowing the small end to extend through the body. By hammering on the small end, the bushing is easily driven out. Hand Forged from Chrome Vanadium steel.

No.	Size	List Price
366F	7/16 to 5/8	\$2.35

Bushing Extractor

Same design as 366F

No.	Size	List Price
367	7/16 to 7/8	\$2.25
368	7/16 to 1	3.90

Ford Drive Shaft Bushing Extractor



No.	Size	List Price
365F	7/8 to 1 1/4	\$4.50

Ford Wheel Puller



No.	List Price
100F	\$1.65

This tool overcomes the objections to the ordinary "Wheel Puller." In using, screw on to axle and use hammer to loosen wheel, by pounding directly on end of tool. This saves time in removing Ford wheels.

Screw Starter



This is a regular screwdriver, made of the best spring steel with the blade split. Pinch the thin blades together and insert into slot of screw head and the screw will stick on—enabling you to start the screw in difficult and hard-to-get-at places in a fraction of the time required by other methods.

No.	Blade	Overall	List Price
95	6	10"	\$0.80

Heavy Duty Screwdriver



Leather Handle

These heavy duty and general purpose screw drivers are hand forged from Chrome Vanadium steel—fitted with sole leather handle—polished. Practically everlasting.

No.	Blade	Overall	List Price
92a	2	6	\$1.50
92b	4	8	1.75
92c	6	10	1.95
92d	8	12	2.25
92e	10	14	2.60
92f	12	16	3.00
92g	14	22	3.50
92h	18	24	4.50

General Purpose Screwdriver



Leather Handle

No.	Blade	Overall	List Price
90a	2	6	\$1.30
90b	4	8	1.60
90c	6	10	1.80
90d	8	12	2.00
90e	10	14	2.30
90f	12	16	2.60

Double Offset Screwdriver



Hand forged from best tool steel and carefully tempered.

No.	Length	Stock	Point	List Price
125	5	1/4	1/4	\$0.45
126	6	5/16	5/16	.55
127	6	5/8	3/8	.65
128	10	5/8	5/8	1.30

Ford Universal Pin Punch



Designed especially for the Ford Universal joint pin—taper is ground exact.

No. Point

Bearing Scraper



Being hand forged, accurately ground and tempered, these bearing scrapers remain in perfect condition longer. They are designed for fast, accurate work.

No.	Description	List Price
43	Small	\$1.35
53	Medium	1.75
63	Large	1.85

Bearing Scraper



Without exception the best scraper on the market.

These bearing scrapers are the best you can buy. Made from the design of able mechanics of years of experience in scraping bearings. Perfectly tempered and designed.

No.	Description	List Price
73	medium	\$2.00
83	large	2.20

Wrecking Bar



No.	Length	Stock	List Price
222a	6"	5/16"	\$0.55
222b	12"	1/2"	1.00
222c	14"	1/2"	1.20
222d	24"	5/8"	1.50
222e	30"	3/4"	2.50

Fender Hammer



For radiator and fender work these hammers have no equal. Designed in our own plant by experienced fender men.

No.	Weight	List Price
1	4 oz.	\$2.50
1	6 oz.	3.00

Buick Cage Nut Drive



Did you ever try to get a cage nut loose with a chisel and hammer? This tool will do the job without damage to the nut.

Cold Chisel



No.	Length	Stock	List Price
10a	5	1/4	\$0.30
10b	5 1/2	5/16	.35
10c	5 3/4	3/8	.45
10d	6 1/4	1/2	.65
10e	7	5/8	.80
10f	8	3/4	.90
Kit No. 5—One each of the above			3.35

Cape Chisel



No.	Length	Stock	List Price
30a	5	1/4	\$0.40
30b	5 1/2	5/16	.45
30c	6 1/2	3/8	.50
30d	7	1/2	.65
30e	8 1/2	5/8	.80
30f	9	3/4	.90
Kit No. 8—One each of the above			3.35

Key Seat Chisel

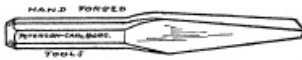

No.	Length	Stock	List Price
40a	5	1/4	\$0.40
40b	5 1/2	5/16	.45
40c	6 1/2	3/8	.50
40d	7	1/2	.65
40e	8 1/2	5/8	.80
40f	9	3/4	.90

Key Drift



No.	Length	Stock	List Price
50a	6 1/4	5/16	\$0.40
50b	6 1/2	3/8	.50
50c	6 3/4	1/2	.80

Diamond Point Chisel

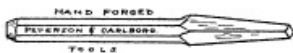

No.	Length	Stock	List Price
60a	4	1/4	\$0.40
60b	4 1/2	5/16	.50
60c	5	3/8	.65
60d	6	1/2	.80

Round Nose Chisel



No.	Length	Stock	List Price
70a	4 1/2	1/4	\$0.40
70b	5	5/16	.55
70c	6	3/8	.65
70d	7	1/2	.80

Oil Groove Chisel



No.	Length	Stock	List Price
80a	6	5/16	\$0.65
80b	6 1/2	3/8	.75

Rivet Shear



No.	Length	Stock	List Price
90a	10	5/8	\$1.00
90b	10	3/4	1.30
90c	12	3/4	1.70

Handled Chisel



No.	Blade Width	List Price
00a	3/4	\$1.30
00b	1	1.70
00c	1 1/4	2.00
00d	1 1/2	2.70

Slim Taper Punch



No.	Length	Stock	Point	List Price
25a	6 1/2	1/4	3/16	\$0.40
25b	7	5/16	1/4	.45
25c	7 1/2	3/8	1/4	.55
25d	8 1/4	1/2	5/16	.70
25e	9 3/8	5/8	3/8	.85
25f	9 3/8	3/4	1/2	1.00
Kit No. 7—One each of the above				3.35

Extra Length Slim Taper Punch



No.	Length	Stock	Point	List Price
35a	12	3/8	3/16	\$0.65
35b	14	1/2	1/4	1.00
35c	16	5/8	5/16	1.30
Kit No. 13—One each of the above				2.75

Pin Punch



No.	Length	Stock	Point	List Price
55a	5	1/4	1/16	\$0.35
55b	5	1/4	3/32	.35
55c	5	1/4	1/8	.35
55d	5	5/16	5/32	.45
55e	5	5/16	3/16	.45
55f	5	5/16	7/32	.45
55g	5	3/8	9/32	.55
Kit No. 14—One each of the above				2.75

Center Punch

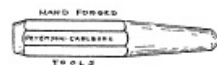

No.	Length	Stock	List Price
45a	3 1/2	1/4	\$0.30
45b	3 1/2	5/16	.40
45c	4	3/8	.45
45d	4 1/2	1/2	.55
45e	4 1/2	5/8	.65
45f	5	3/4	.80

